

Area of Rectangles, squares and parallelograms

Find the area of the following;

1

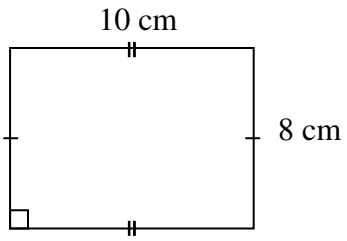

2

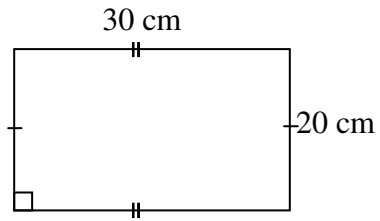

3

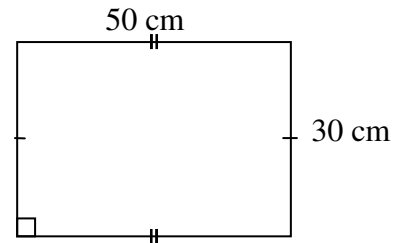

4

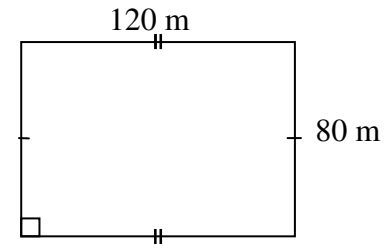

5

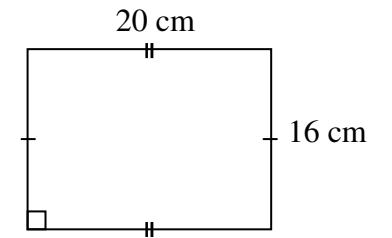

6

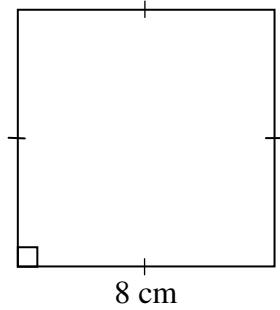

7

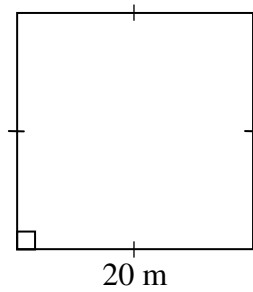

8

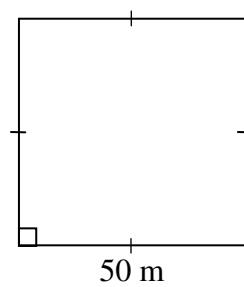

9

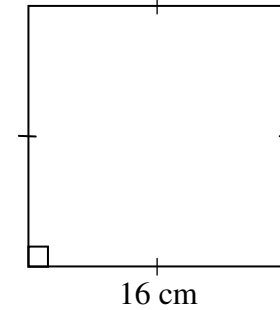

10

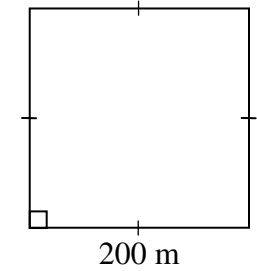

11

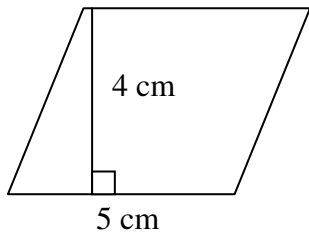

12

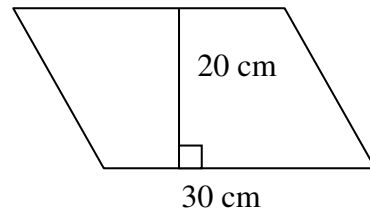

13

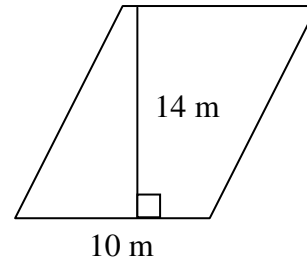

14

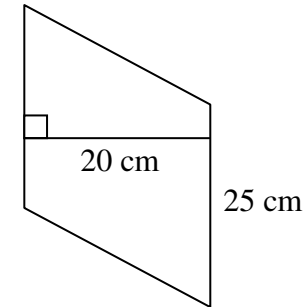

15

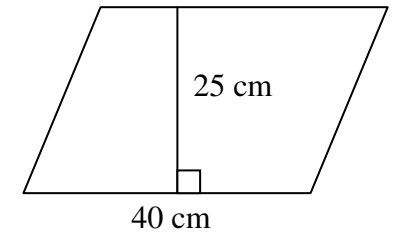

16

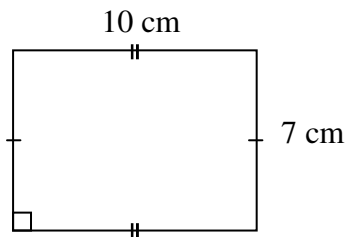

17

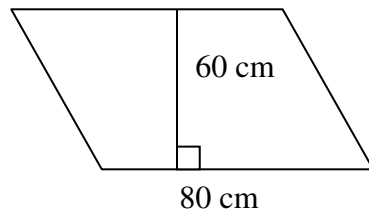

18

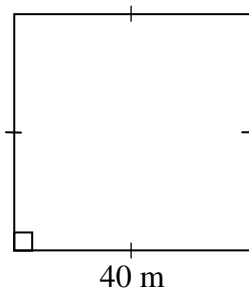

19

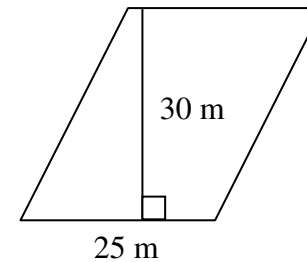

20

